



Acoustical Surfaces, Inc.

SOUNDPROOFING, ACOUSTICS, NOISE & VIBRATION CONTROL SPECIALISTS

123 Columbia Court North • Suite 201 • Chaska, MN 55318

(952) 448-5300 • Fax (952) 448-2613 • (800) 448-0121

Email: sales@acousticalsurfaces.com

Visit our Website: www.acousticalsurfaces.com

We Identify and S.T.O.P. Your Noise Problems

The high-tension fabric wall mounting system

wallmate[®]

WE COVER SOUND CONTROL

Acoustically treated walls are often essential in this digitized, amplified, surround sound age of technology.

Increased demand for sound control has encouraged many construction professionals to add acoustical substrates and decorative fabrics to their list of services.

Wallmate covers acoustical substrates and is a premier two-piece, high tension, fabric mounting system used for custom on site installations.

Wallmate's unique engineering and design yields professional results: highly tensioned spans of fabric with positive locking and unlocking capability.

INSTALLATION GUIDE

- Soundproofing Products • Sonex™ Ceiling & Wall Panels • Sound Control Curtains • Equipment Enclosures • Acoustical Baffles & Banners • Solid Wood & Veneer Acoustical Ceiling & Wall Systems
- Professional Audio Acoustics • Vibration & Damping Control • Fire Retardant Acoustics • Hearing Protection • Moisture & Impact Resistant Products • Floor Impact Noise Reduction
- Sound Absorbers • Noise Barriers • Fabric Wrapped Wall Panels • Acoustical Foam (Egg Crate) • Acoustical Sealants & Adhesives • Outdoor Noise Control • Assistive Listening Devices
- OSHA, FDA, ADA Compliance • On-Site Acoustical Analysis • Acoustical Design & Consulting • Large Inventory • Fast Shipment • No Project too Large or Small • Major Credit Cards Accepted

THE WALLMATE PROFILES

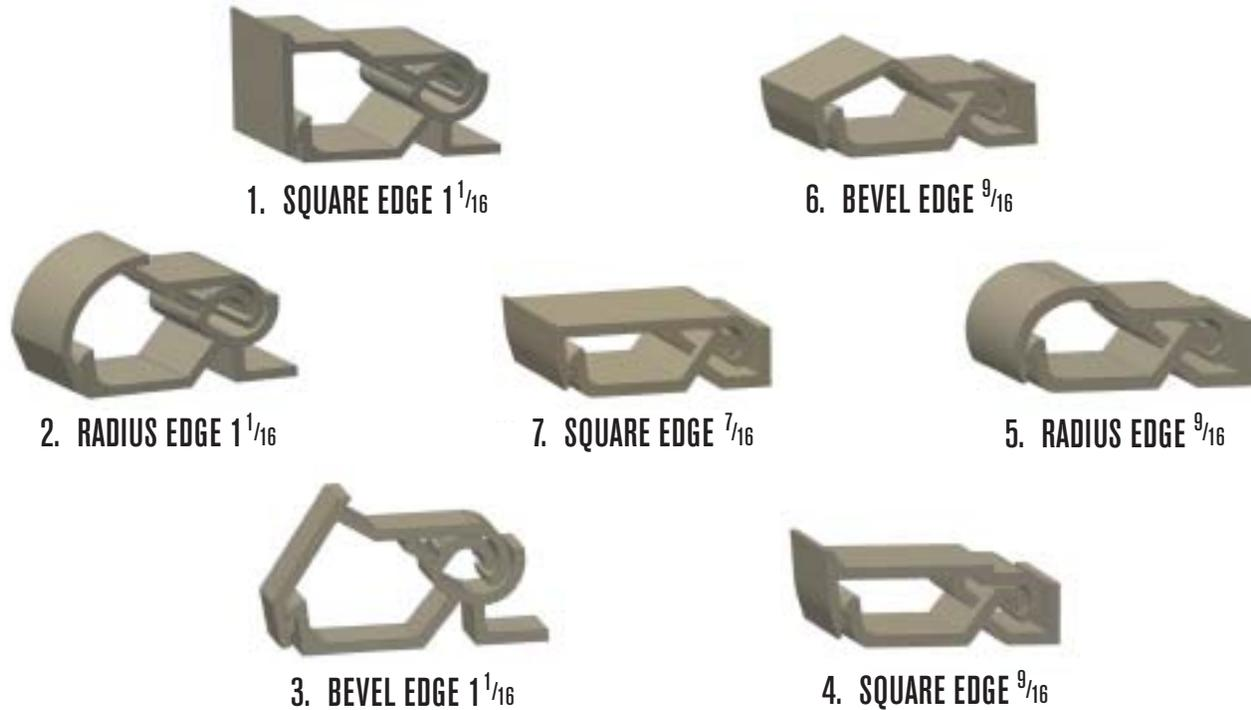

THE WALLMATE DESIGN

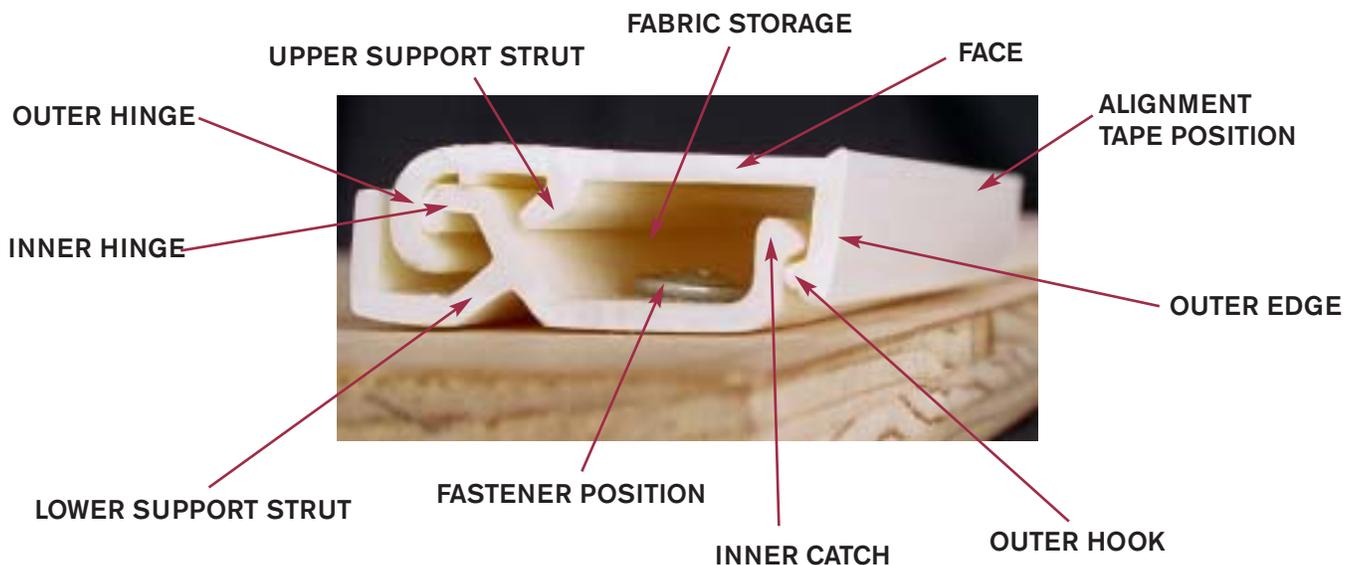

Two piece design facilitates securing system to the mounting surface.

Strong, rigid and functional: hinge design incorporates strut supports which transfer fabric tensioning forces directly to mounting surface.

Rotating outer profile:

1. enables installer to align fabric without the material being under tension.
2. controls degree of tension possible. Rotation stretches, tensions and locks fabric into position.

PRODUCT OVERVIEW

ILLUSTRATED: 7/16 SQUARE EDGE

Two piece design facilitates securing system to the mounting surface.



EASY MOUNTING ACCESS

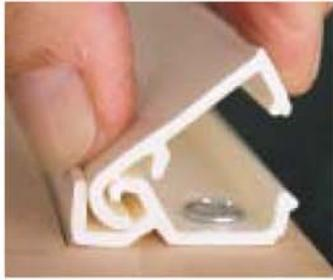

OUTER IS IN POSITION

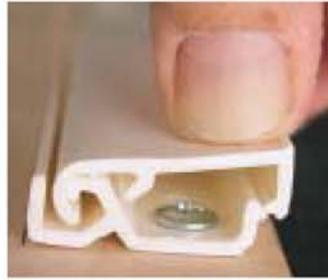

DOWNWARD PRESSURE



CLOSED AND LOCKED

The outer profile snaps into its mounting and forms a working hinge on one side and a locking catch on the other.

1 1/16 PROFILES



< In addition to the 7/16 and 9/16 profiles 1-1/16 profiles work with 1 inch Echo Eliminator (Bonded Acoustical Cotton) which contain no formaldehyde. The extra 1/16 inch helps cover irregularities in panel thickness.



The outer profile is able to rotate from an open to a closed position. This rotation enables the fabric placed over the outer edge to stretch, tension and lock securely in place. Note that double sided alignment tape was applied. This allows for precise positioning and re-positioning of fabric when necessary.



NOTE THE ALIGNMENT OF THE PATTERN IN THIS PICTURE. Considerable tension can be created. Under tension, fabric will try to pull and rotate the attaching system off and away from the mounting surface. Wallmate takes these forces and directs them down into the mounting surface. High tension locking is obvious. Wallmate remains strong and rigid.

LAYOUT AND PREPLANNING

FABRIC MUST BE APPROPRIATE FOR USE WITH THE WALLMATE SYSTEM

It must be noted in advance that because of the wide range of available fabrics having differing weights, thicknesses and compositions, the purchaser/installer must determine the compatibility between fabric and track. This will be a consideration basic to all installations.

From a simple sketch to a full set of architectural drawings, preplanning any installation is important.

The wall design determines the layout.

ILLUSTRATION A1 *

A simple wall section. Wood slats separate the panels. Detail is clear and easy to follow. Amount of track and fabric is easily determined.

Fabric width is a consideration. Provide for the extra fabric needed to wrap into the track. For 1 1/16 track add 4 inches; for 9/16 track, add 3 inches.

If fabric is 54 inches, 1 1/16 panels should be no greater than 51 inches; for 9/16 inch panels, the maximum width should be 50 inches.

Develop a checklist. Examine the walls for condition. Is the wall straight, secure, safe (does it need fire tape, etc.)? Are there outlets, lights, registers, alarms, or any hanging or supported items that need special treatment? What is the depth of the installation and will furring be necessary? What is the substrate and which choice of fastening will be used?

Advance preparation saves time during installation. Examine the options for using flame retardant MDF for outlet and sprinkler extensions and for making outside corner pieces ahead of time. Miters can be pre-cut, lefts and rights at 46 degrees each.

*** The following list of illustrations will be helpful during the pre-planning process. Please refer to pages 15-25 (ADDENDUM) at the end of this document:**

Illustration Number

- A 1. Auditorium elevation, simple wall section
- A 2. Outlet detail in joint application
- A 3. Sprinkler Extension Ring, Top Joint Application
- A 4. Sprinkler Extension Ring, Joint Application
- A 5. Sprinkler Extension Ring for Screw On Covers
- A 6. Typical MDF Single Outlet Extension
- A 7. Wood corner piece used for Outside Corners
- A 8. Corners and ceilings; track spacing for each surface
- A 9. Track and crown molding details
- A 10. Curves

MISCELLANEOUS

Applying Fabric to MDF

When using MDG to mount fabric onto a surface or edge, treat the MDF first with a spray adhesive such as Wide Web Acoustical Spray Adhesive (AGS-12). Allow to dry. Alignment tape will hold very well with this surface preparation. An alternative to sealing and using tape is to simply staple the fabric into place.

PREPARING TO INSTALL

Wallmate is made from a plastic resin. It can be easily cut, mitered, drilled, nailed, stapled or screwed and glued; obviously, proper attachment to the mounting surface is of great importance when installing a high tension product.

This process requires that you understand all of the steps. Please do not rush, thinking that your intuition will guide you. While the steps are relatively simple, they need to be followed to achieve professional results. Let's begin.



Having the correct tools and the ability to use them safely is very important. We recognize that there is a broad range both in installer skill level and the type of equipment that is available. The options can range widely.

Basic: Fine tooth miter and miter box, drill, measuring tape, pruning shears (as in cutting roses which is good for cutting the 9/16 base track), scissors, drill, tuck in tool, dull putty knife, a padded block when closing the track with a hammer, some sandpaper and 24 inches of lightweight sash cord.

The professionals who are fully equipped may have laser driven beams for measuring and alignment, professional quality hand

cutters, pneumatic staple guns that have a longer nose to reach into the base tracks; right angled awls and stuffing tools, upholstery scissors and a power miter saw with a saw blade made for veneers. Blades with a narrow kerf and a lower number of teeth are preferable.

Our biggest concern is safety. **Please wear protective eyewear whenever cutting or when in the vicinity of someone who is using a power saw.** Cutting Wallmate requires that both top and bottom profiles be joined so that each extrusion gains support and strength by being joined together. Cuts should start when the blade reaches full RPM. With the track held tightly against a rear guide, slowly guide the blade through the material. Allow the blade to stop before removing the material. Thank you practicing good safety.

PNEUMATIC STAPLERS

The use of pneumatic staplers for fastening track to drywall requires a specific technique using narrow crown, 3/4 inch long (minimum) staples.



After positioning the track with temporary staples, so that it is in place and cannot move, secure the track permanently by **DIVERTING** the direction of the staples. Position the staple gun at a 45 degree angle to the left, shoot; and, within an inch, position the gun to an angle of 45 degrees to the right and shoot. Space several inches and repeat along the full length of the track.

When both top and base of track are joined, never pull on the top track to open. Always use a right angled awl or another tool to reach in at a corner and pry against the base to spring the top open. This is very important as we do not want to pull the track away from the wall or loosen its attachment.

MOUNTING THE BASE



Pictured are the base mounting tracks. On the left is the common base used for all profiles that are 9/16 and 7/16 inches. The larger on the right is the common base used for all 1 1/16 inch profiles.



There is ample room in the fastening area to secure the track. Earlier, we noted that the track can be drilled, nailed, stapled, screwed or glued. We must continue to stress the importance of secure, tight fastening. A general guide is to secure the track every 2-3 inches.

Care must be taken not to distort the shape of the track or interfere with the catch when fastening the track to the wall.

When extra tension on the track is anticipated, place fasteners as close to the catch as possible.

APPLYING TRACK TO WALLS

When installing track, do the verticals first, using the correct spacing as needed for seams and edges; then, install horizontal members.

INSTALLING TRACK END TO END (BUTT JOINTS)

When butting one length of track to another, make sure that the outer track bridges the joint. The result will appear to be a seamless length.

POSITIONING THE BASE



For the 7/16 and 9/16 track, the base is installed 1 1/2 inches from the corner in each direction. This creates a cavity in each corner into which excess corner fabric will be stored. The inside edges are 90 degrees to each other.

For 1 1/16 track, it is recommended that base track be mitered in the corners; cut each base corner short so that a 1/2 inch mitered gap remains open. Fabric is tucked into the creases where the outer track is mitered as against being wrapped or pulled under for the 7/16 and 9/16 tracks.

MEASURING FOR MITERS MADE EASY

A colleague uses this simple technique for accurately measuring the length needed for a miter. The photos tell it all.



MITERS

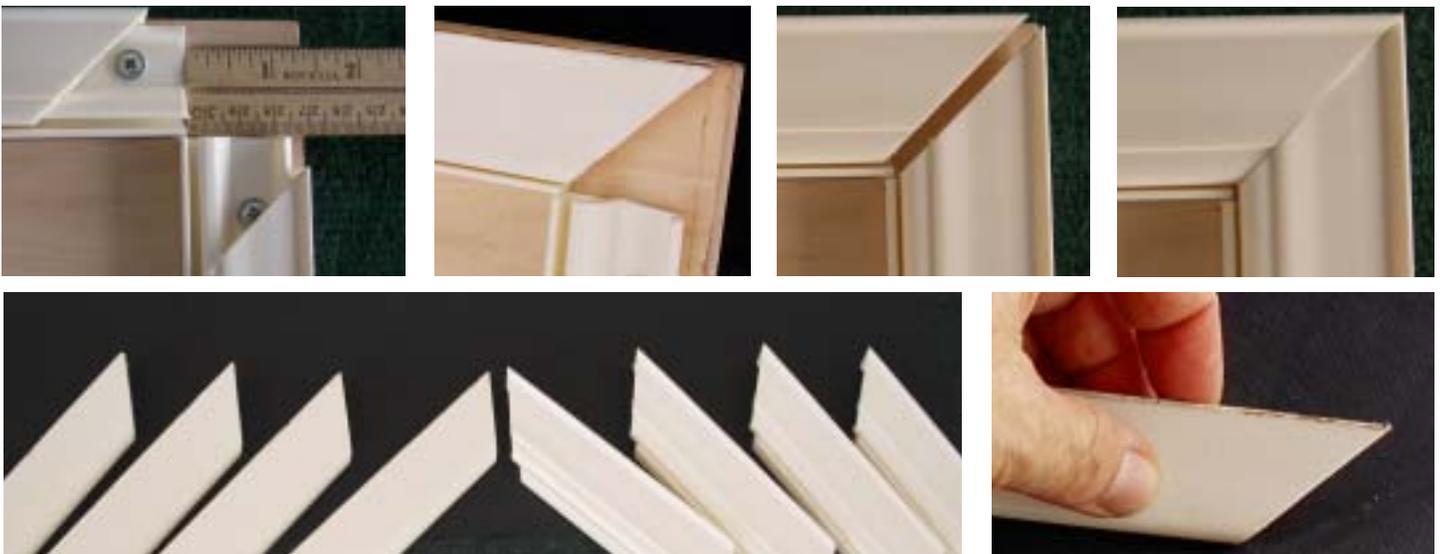

Again, be safe when using power saws to cut miters. Wear eyewear protection.

When cutting, join base and outer profile for stability. (You do not need to join a full 8 foot length, just a couple of feet.) The outer profile edge of the track will be the longer. The hinge side will be the shorter.

Most installers will measure and cut miters to length. When the job is large, many miters, rights and lefts, can be cut at one time to a reasonable length, 24-36 inches. At the jobsite, they cut the center sections which are simple 90 degree cuts, and fill.

Note: Mitered edges can be sharp. Take a moment to touch these with sandpaper. This will prevent the possibility of a sharp point poking through the fabric later.

MAKE A 45 DEGREE MITER CUT, 46 DEGREES

Because the outer hinge is round, when the track is opened, it rotates and may touch the hinge portion on the adjacent track. 46 degrees gives some more room and if it still is too tight, take a pruning sheers and nip off a 1/4 inch or so of the hinge on the outer profile.

ALIGNMENT TAPE

Double sided alignment tape is applied to the perimeter edge of the Outer Profile track and is protected by a cover strip.



Consider alignment tape as being extra hands capable of holding fabric in place while you position, trim and lock the fabric in place. In the event of a mistake, simply open the track and correct the error.

Some installers prefer to install the alignment tape before snapping the outer profile to the base.

When ready, insert the horizontal outer profile tracks into their bases. Do not close at this time. For vertical tracks, insert hinge portion and snap a couple of feet closed to keep the track from sliding downward.

HARDWARE, ELECTRICITY, FIXTURES, ALARMS, SPRINKLERS

All of the above need to be addressed before installing acoustical batting or padding and the final fabric finish.

Details concerning special brackets and other supports such as for heavy paintings, ornaments or other fixtures should be completed prior to covering.

Plans for electrical extensions and sprinkler fittings are in the addendum.

INSTALL PADDING OR ACOUSTICAL BATTING

CUTTING FABRIC

Standardize procedure for cutting fabric. Always do it the same way; keep the bolt direction the same. Place a piece of tape to mark the top of each piece of fabric. Inverted fabric can be disturbingly noticeable.

MOUNTING THE FABRIC

In just a short time, we have installed our base, joined our outer profile to complete the hinge, checked for sharp edges on corners and made sure our miters fit. The protective covering on the alignment tape can now be removed as we are ready to install and stretch the fabric.

Starting at the ceiling, remove the protective cover on the edge tape.



1. Take the time to position the fabric along the topmost track. As you begin to position the material, you can slightly tension the material horizontally.



2. Follow a thread line or pattern, or in the case of a microfibre, your feel for positioning the material. In the demo panels used for these photographs, note how well the pattern is aligned. If you are not in line, simply reposition. The system welcomes the chance to make corrections.



3. Trim the fabric to 1 1/2 to 2 inches beyond the edge of the track. When ready to close, fold the material in under the outer profile and close the track. As you near the corner, allow the excess fabric to stay out, we will address corners shortly.



4. It is always interesting to see a section of fabric begin to tighten. As you proceed from top to bottom and side to side, the once loose, possibly wrinkled wall becomes taut. Do not overtension however. Develop a feel for how much angle on the outer track you actually need to achieve a particular tension. There are times when you will use a padded block and hammer to close the outer track. On the 9/16 square edge, position the block behind the raised edge which can mar a sensitive fabric.



5. Excess fabric in the corners may need to be trimmed back.



6. Repeat the process until the wall is stretched evenly; minor corrections can be easily corrected.

CORNERS

In the beginning, we mounted the base and left a vacancy in the corners.
In this section, we're going to see why.



When the track is closed and the fabric trimmed to within 2 inches of the track, fabric remains in the corner. If there is a lot, trim some back...but not too much.

Make sure that your broadknife is dull and corners are slightly rounded. We do not want to tear or cut the material!

The main panel of fabric is now locked in and all that remains is to finish the corners. There is little or no fabric tension on the corners. Pull the corner excess diagonally and use the broad knife to position the fabric against the outside corner edges. We do this by holding the blade vertically, pushing the fabric into place along both sides.

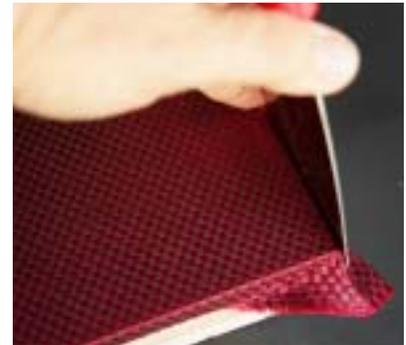

If the corner is accessible, take the dull broad knife and carefully push the excess in from the side.

If our panel is an inset panel and is not accessible from an edge, we have options:

1. Keep both sides of the track open for the last 6-8". Using our broad knife and the right angled awl, push the fabric under and push the track closed.
2. Float the outer profile away from the base, which means that both sides of the miter are not joined at the hinge, but remain open. As long as

the excess fabric that is folded under does not interfere with the hinge being rejoined, OK. The track is pliable, push or use your block and mallet to lock it in.

3. Use a couple of feet of lightweight sash cord. First, using the broadknife, push the chord along the outside edges of the track on both sides of the miter. Then, push the cord in and down each side of the mitre. Holding the cord pull the excess fabric into the corner. This is amazingly simple. When the fabric is in place, pull on one end of the cord to remove.

At this point, we look at how one panel of fabric is installed to an adjacent surface or to a panel of fabric, side by side. We need to recognize that SPACING IS THE KEY TO PERFECTION.

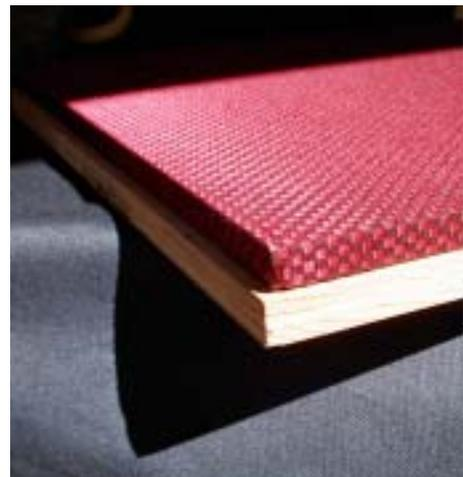

SPACERS AND SEAMS

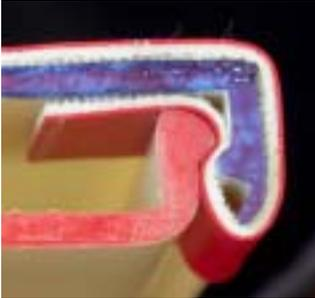

Please look carefully at the photo. Just like a set of teeth, the uppers are designed to fit over the lowers. The lower, base mounting cannot be installed flush against an adjacent surface. If it were, the upper, or the outer profile could not close.

The base, then, must be set back. We need to adjust for the combined thickness of the outer profile and the fabric to be used. We call this measurement a setback distance.

“How do we determine and measure for the setback?”

MAKING AND USING A CUSTOM SPACER

With the tracks you plan to install, cut a short length of base track approximately 10 inches in length; also, cut a length of outer track ...shorter, to 6 inches.

Place alignment tape on the outside edge of this outer track and for convenience on the face as well and install a piece of the fabric you will use.

Placing one end of the outer profile over an end of the base, join both top and bottom and close. The base track extends 4 inches. We now have a tool to measure spacing.

Track is going up against an adjacent surface. Holding the fabric portion of the tool firmly against the surface, the distance between the base track and the surface is your spacer size. Make a spacer out of cardboard, wood, plastic, etc., to fit between the surface and the base.

Lastly, when mounting the base against such an edge, position the spacer first, place the base track against the spacer and fasten the base in place. Because you made a custom measurement and a custom spacer, you will have a custom fit.

SEAMS

When placed up against an edge, we know that a base needs to be set back to allow room for its outer profile, with fabric, to rotate closed without binding.

We described how to determine a setback by using a portion of the track as a tool for measuring the space needed.

Spacing a seam differs from spacing an edge. When two profiles face each other to create a seam, there are two setbacks, not just one.

In the photos, we'll keep the fabric off and examine how you measure for a seam.

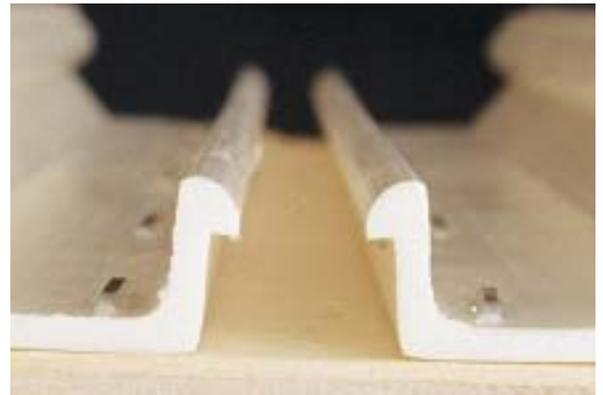
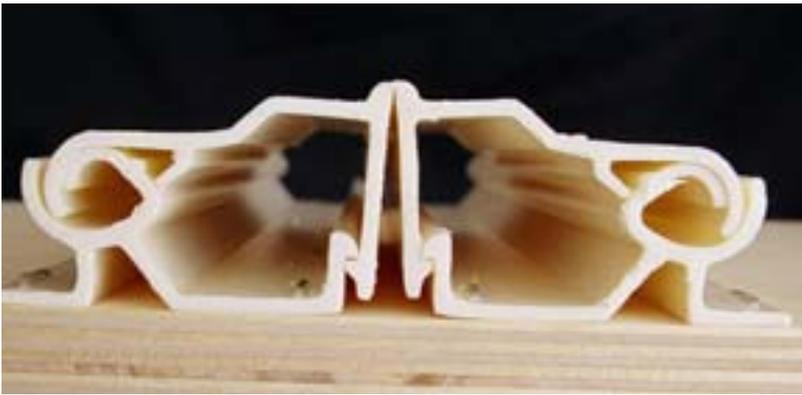

For seams, on a scrap piece of wood mount a length of track to be used (with the fabric as before), and secure to the wood. Mount the same track (with fabric) in the opposite direction. Secure them to the board.

Remove the outer profiles leaving the bases in position.

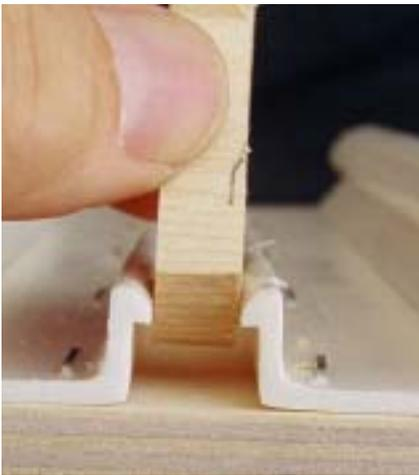

Make a spacer that fits between each base hook.



Check the distance using the spacer to measure a new seam. Adjust if not perfect.

Try out the seam to confirm.



THE OUTSIDE WALL CORNER



An outside wall corner is framed as illustrated. The key is to preparing a full length MDF or comparable corner piece that is cut in advance. At 3 inches wide, it enables a secure attachment to corner framing. The outside edge is angled back 15 degrees to prevent telegraphing. Ends are mitered on site. The resulting corner edge is sharp.

Fabric is attached to the top two sides (or three if it is a column) and locked in; the fabric needs to be notched at the intersections to prevent bunching; then in order, the left side is locked, right side, bottom left and bottom right.

WALLMATE® LIMITED WARRANTY

Because of the wide range of fabric weights, thicknesses, compositions and installation processes, the purchaser/installer must determine the compatibility between fabric and track.

All Wallmate® materials sold by Fabric Wallmount Systems, LLC are warranted against defects in material when used and installed in accordance with prescribed installation procedures common to this industry, under normal use and service for a period of one (1) year from date of purchase.

If the product should fail under normal use and service because of such defect, Fabric Wallmount Systems, LLC, will replace the defective part only at our cost, providing the original part is returned to our facility for inspection- transportation prepaid- within thirty (30) days after the defect is discovered. Our liability under this warranty is expressly limited to replacement of the Wallmate® product. In no event shall Fabric Wallmount Systems, LLC, be liable in any way for consequential or incidental damages to any fabrics or materials other than the Wallmate(r) product.

We make no other warranties, either express or implied.

Wallmate® products are Patent Pending, domestic and international rights reserved.

ADDENDUM

A 1. AUDITORIUM ELEVATION, SIMPLE WALL SECTION ILLUSTRATED

AUDITORIUM ACOUSTICAL WALL SECTION:
SCALE: 1/2" = 1'

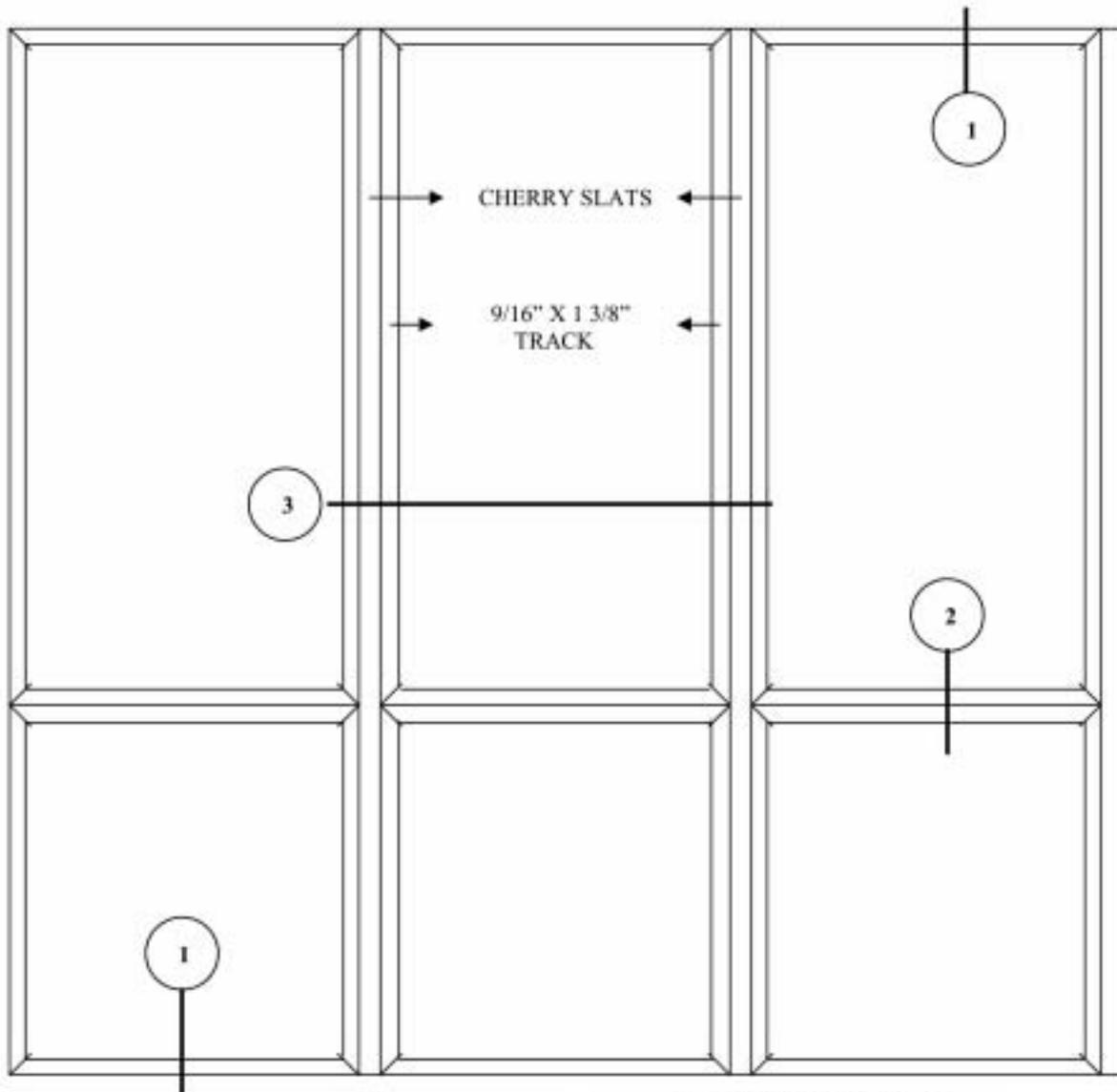

1 TOP & BOTTOM JOINT DETAIL
1" = 1"

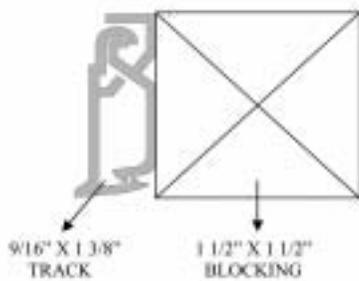

2 HORIZONTAL JOINT DETAIL
1" = 1"

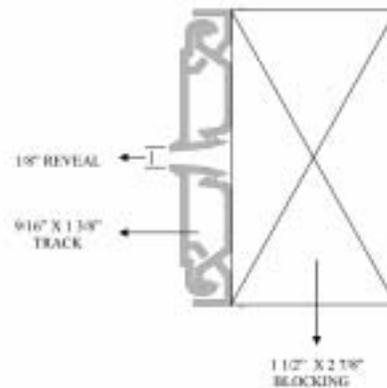

A 2. OUTLET DETAIL IN JOINT APPLICATION

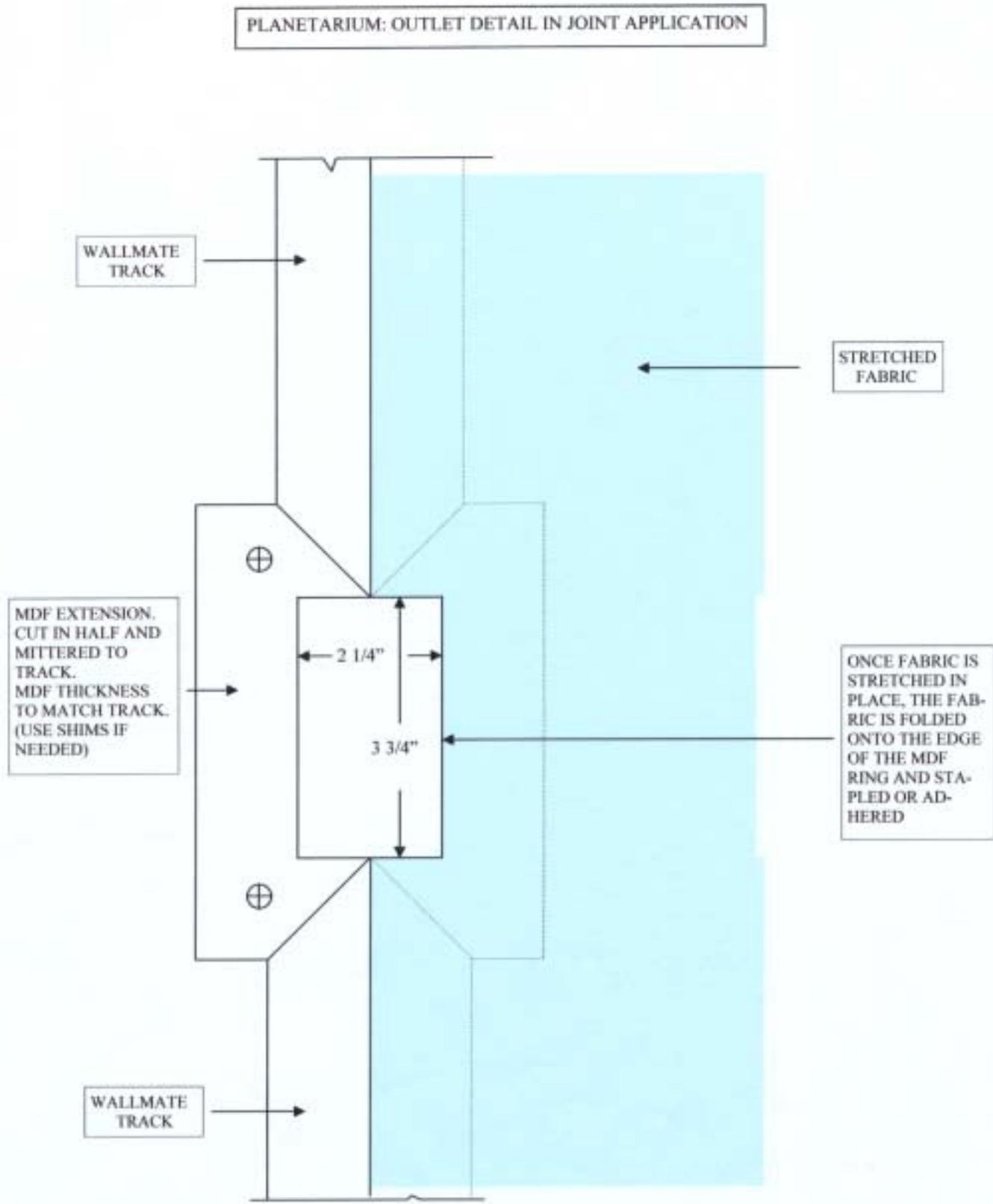

A 3. SPRINKLER EXTENSION RING, TOP JOINT APPLICATION

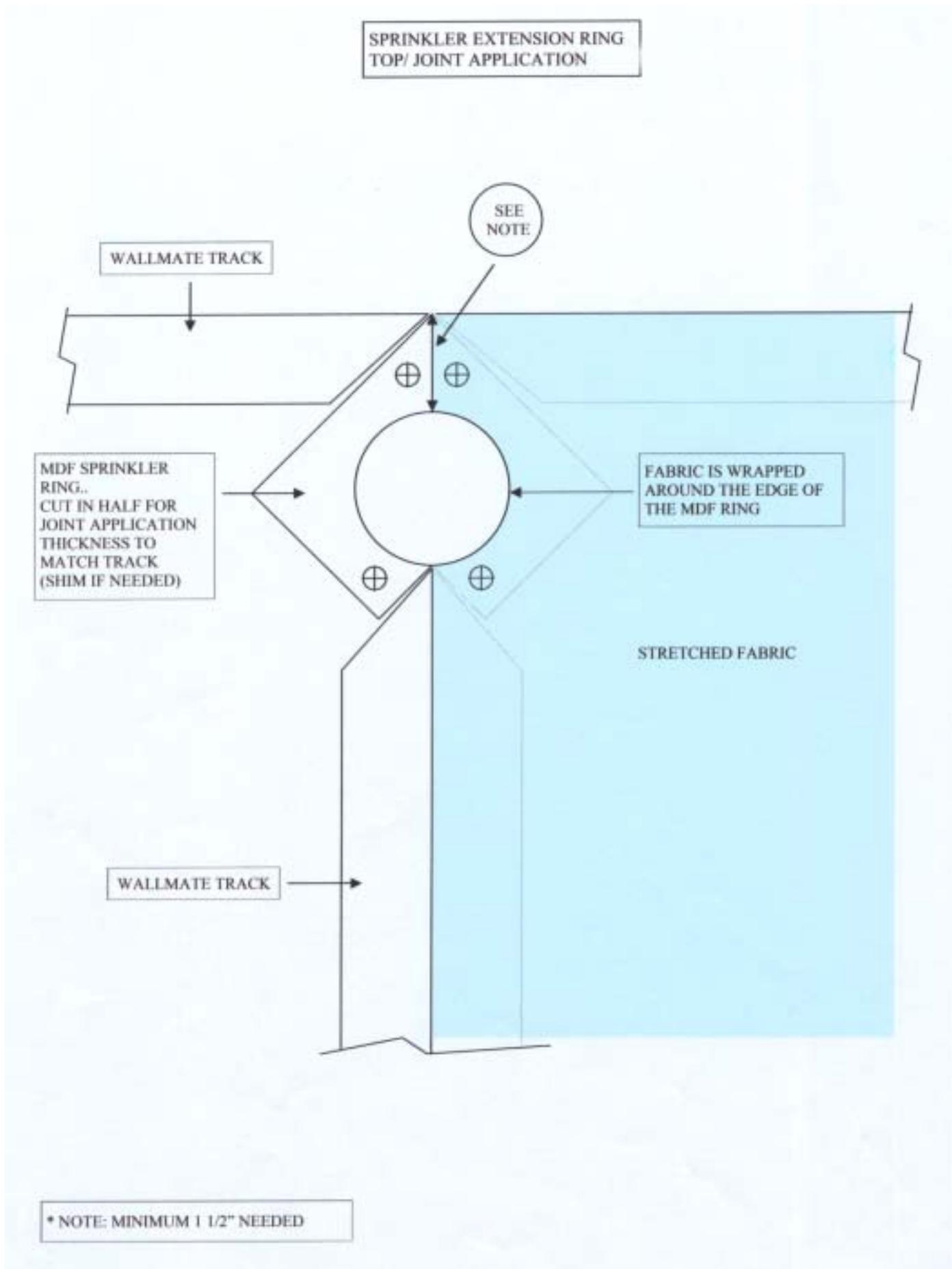

A 4. SPRINKLER EXTENSION RING, JOINT APPLICATION

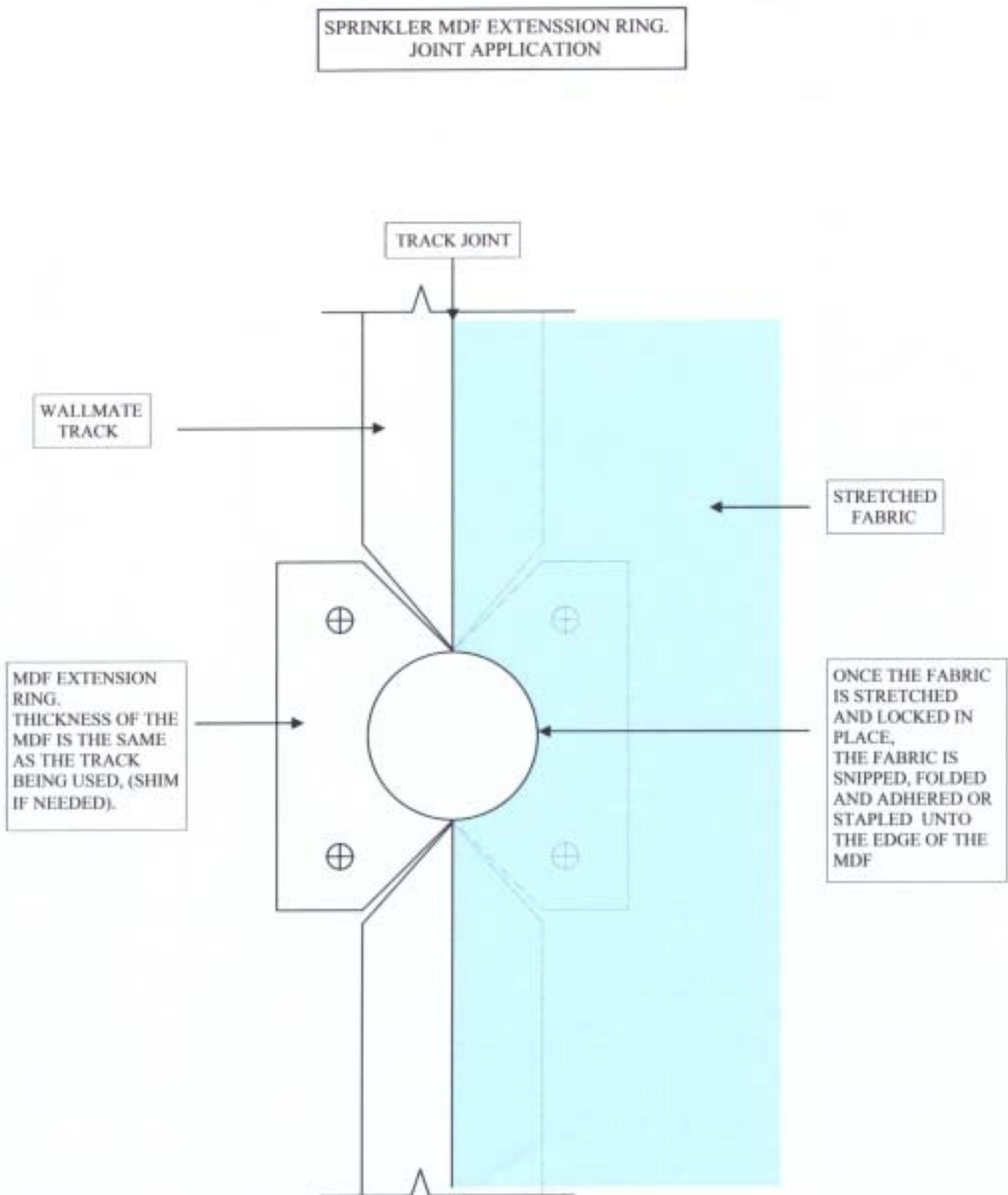

A 5. SPRINKLER EXTENSION RING, FOR SCREW ON COVERS

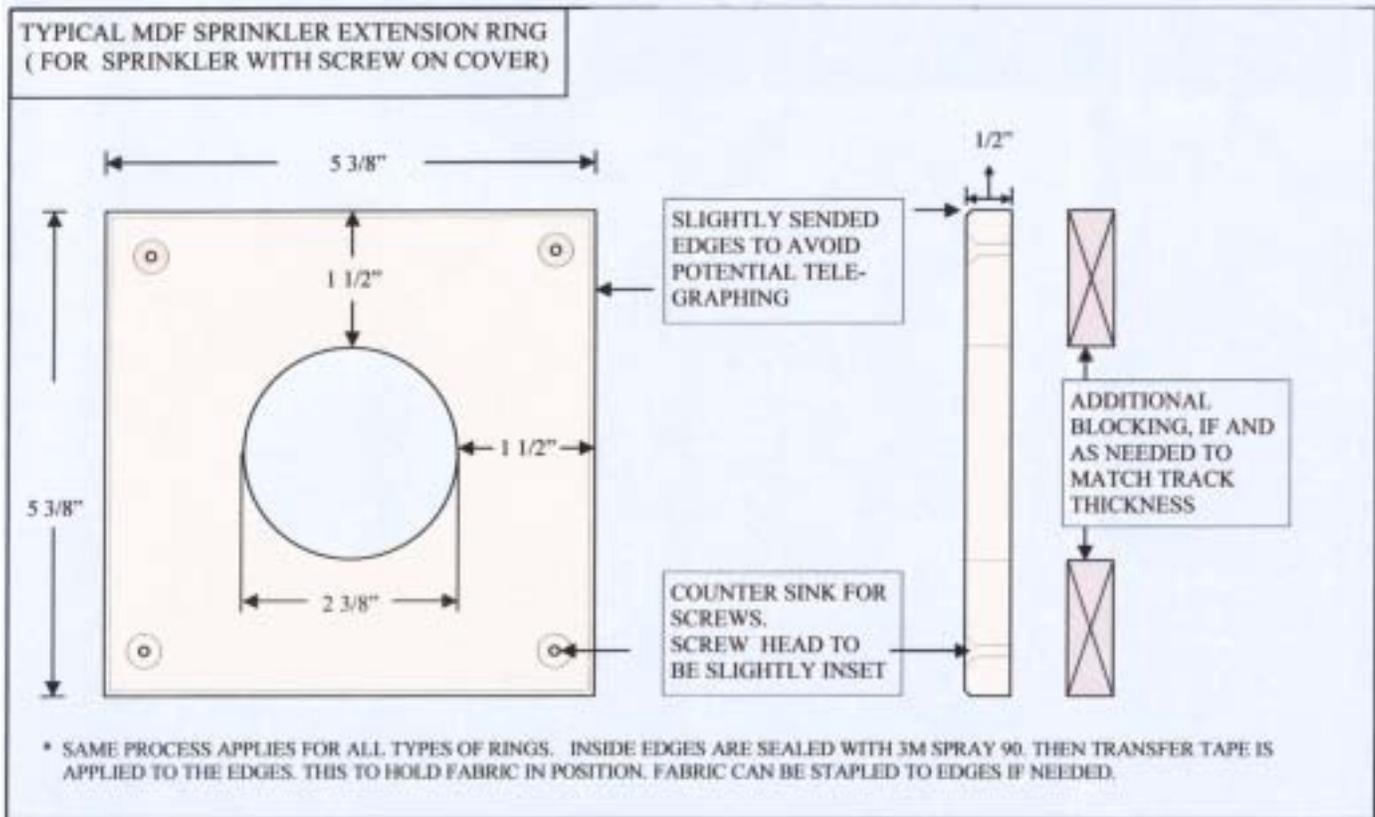

A 6. TYPICAL MDF SINGLE OUTLET EXTENSION DETAIL

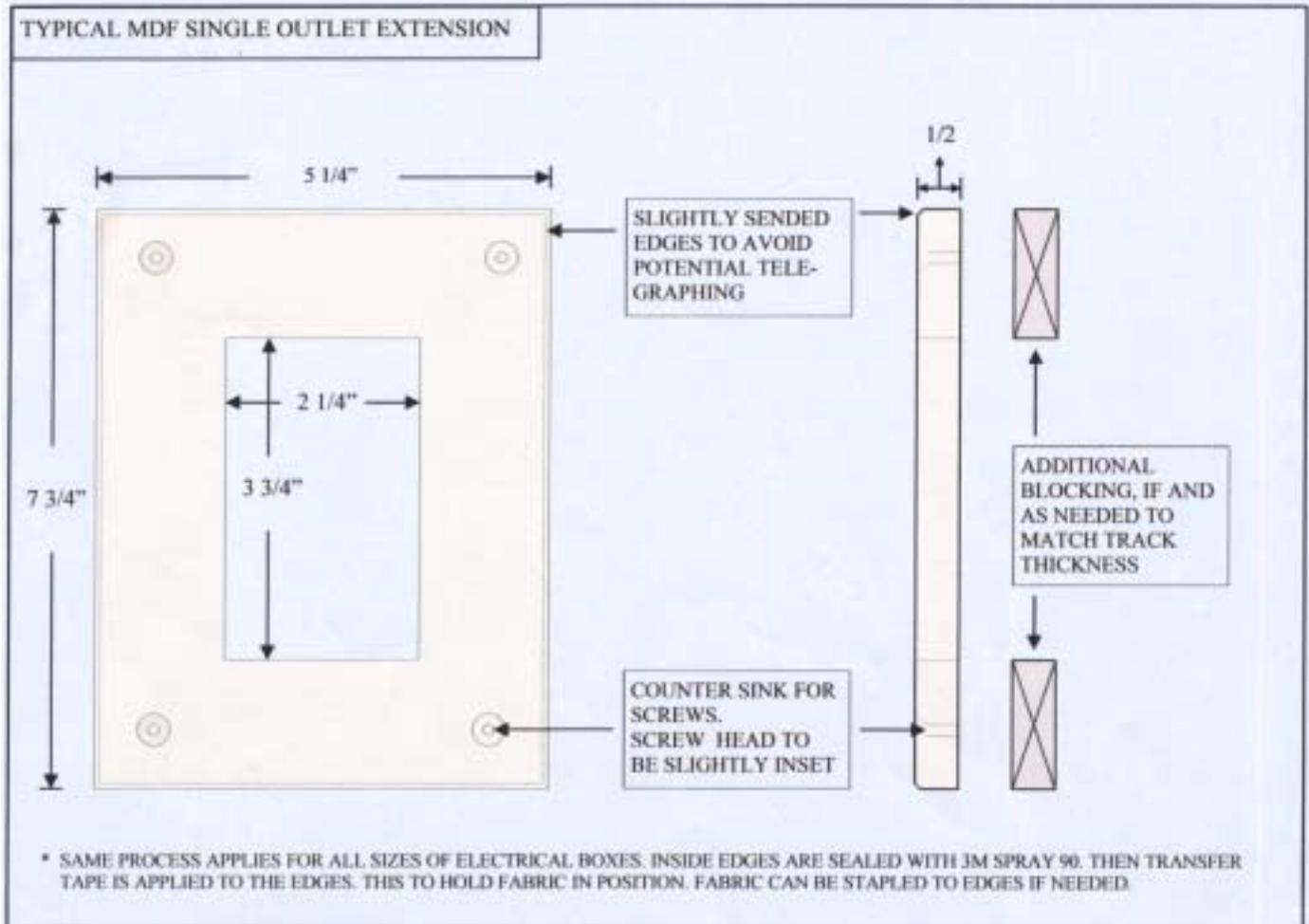

A 7. WOOD CORNER PIECE FOR OUTSIDE CORNER WALL

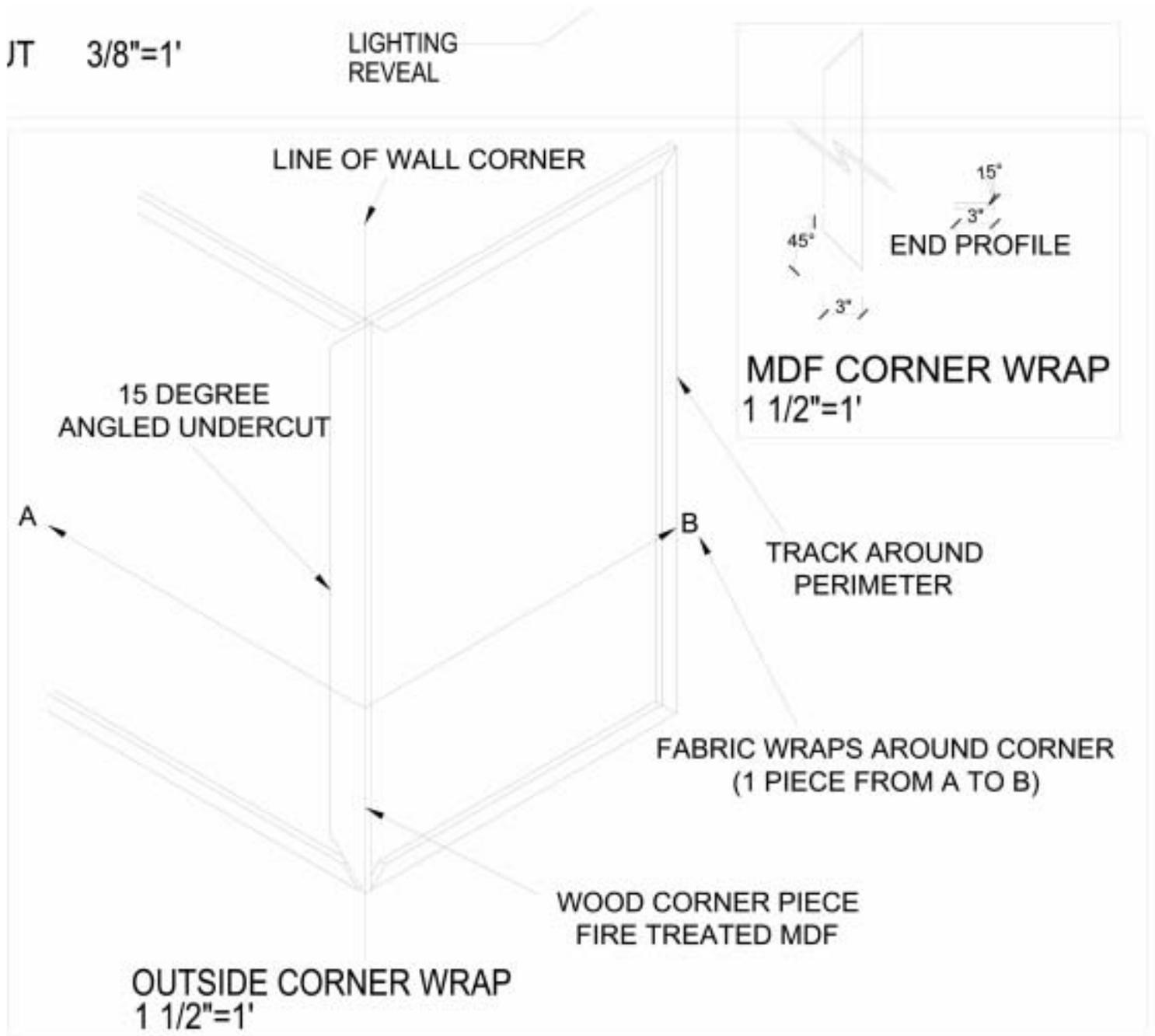

A 8. MOUNTING 9/16 SQUARE TRACK IN CORNER APPLICATIONS

9/16" square at wall corners

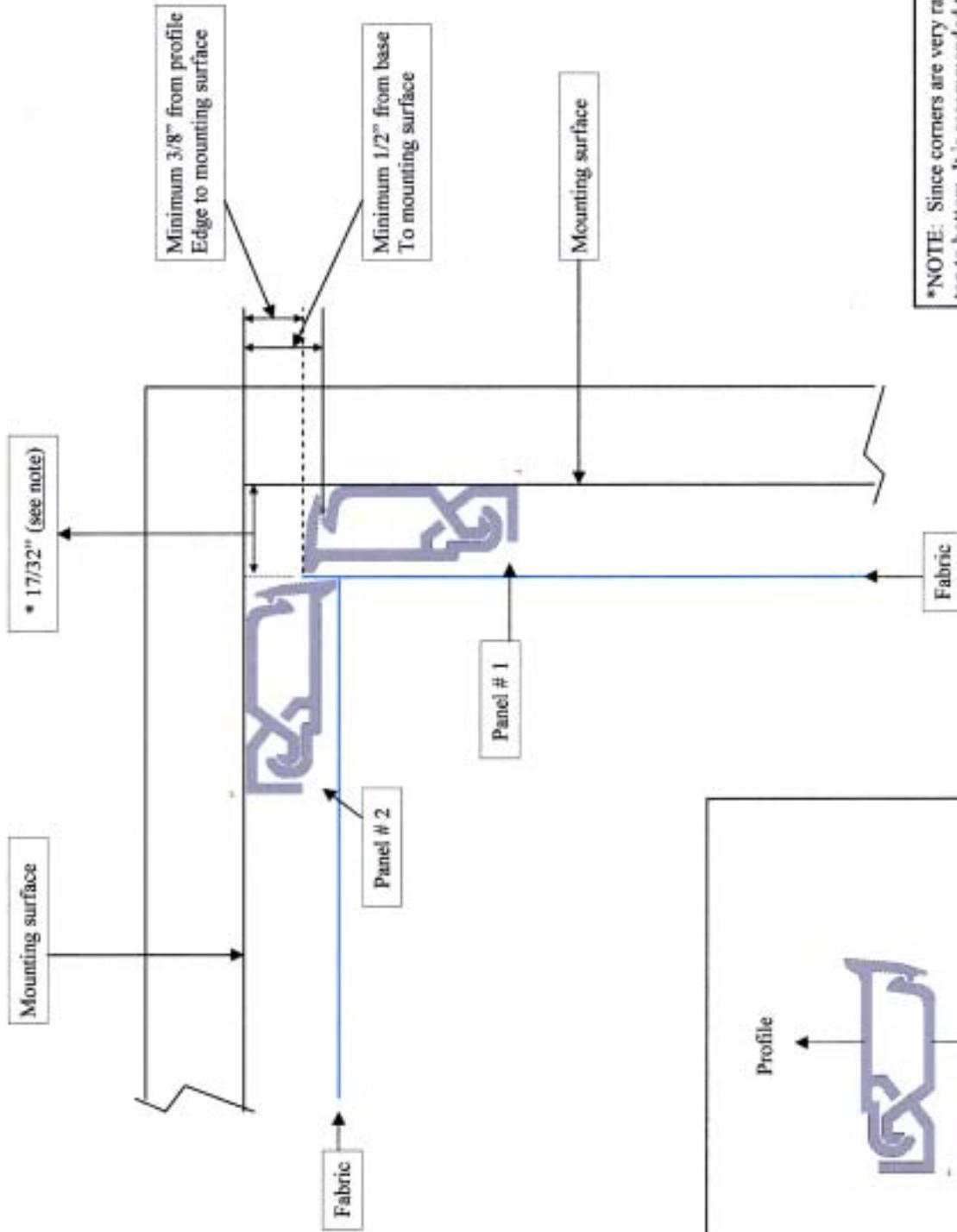

*NOTE: Since corners are very rarely consistent from top to bottom, it is recommended to first install panel #1 complete with fabric then butt panel #2 into completed panel #1. This will provide a consistent butt joint panel to panel.

A 9. MOUNTING 9/16 SQUARE TRACK IN CORNERS ON FIRRING

19/16" corner with blocking

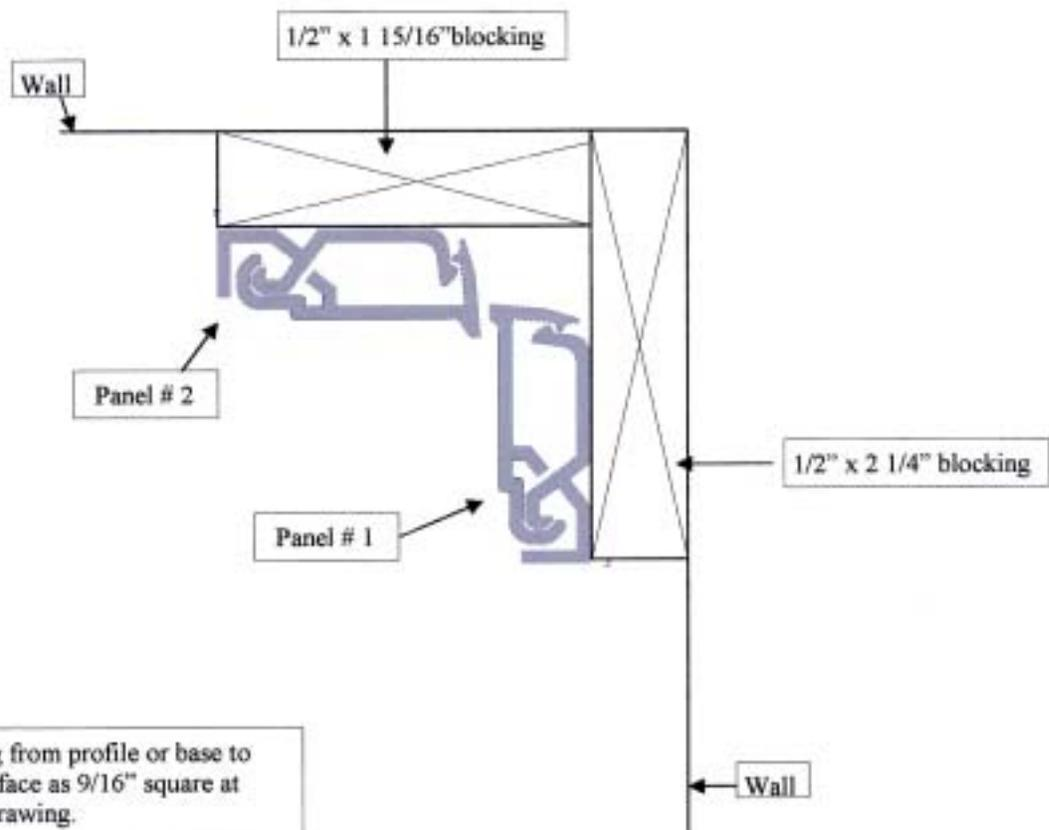

A 10. DETAIL OF SQUARE TRACK TRANSITIONING TO BEVEL TRACK

Transition between square and bevel profiles
Horizontal joint in wall panel meeting in corner.

Bevel track is cut in two steps:
#1 it is cut square on both ends, to length
#2 it is cut at a 46 degree angle from the
pick of the bevel to the back of the base.
Once the bevel install, measure the length
of the square track and reduce by 1/32",
cut 46 degree on both ends and install
(The extra degree + 1/32" will prevent
Tracks from biding at corners).

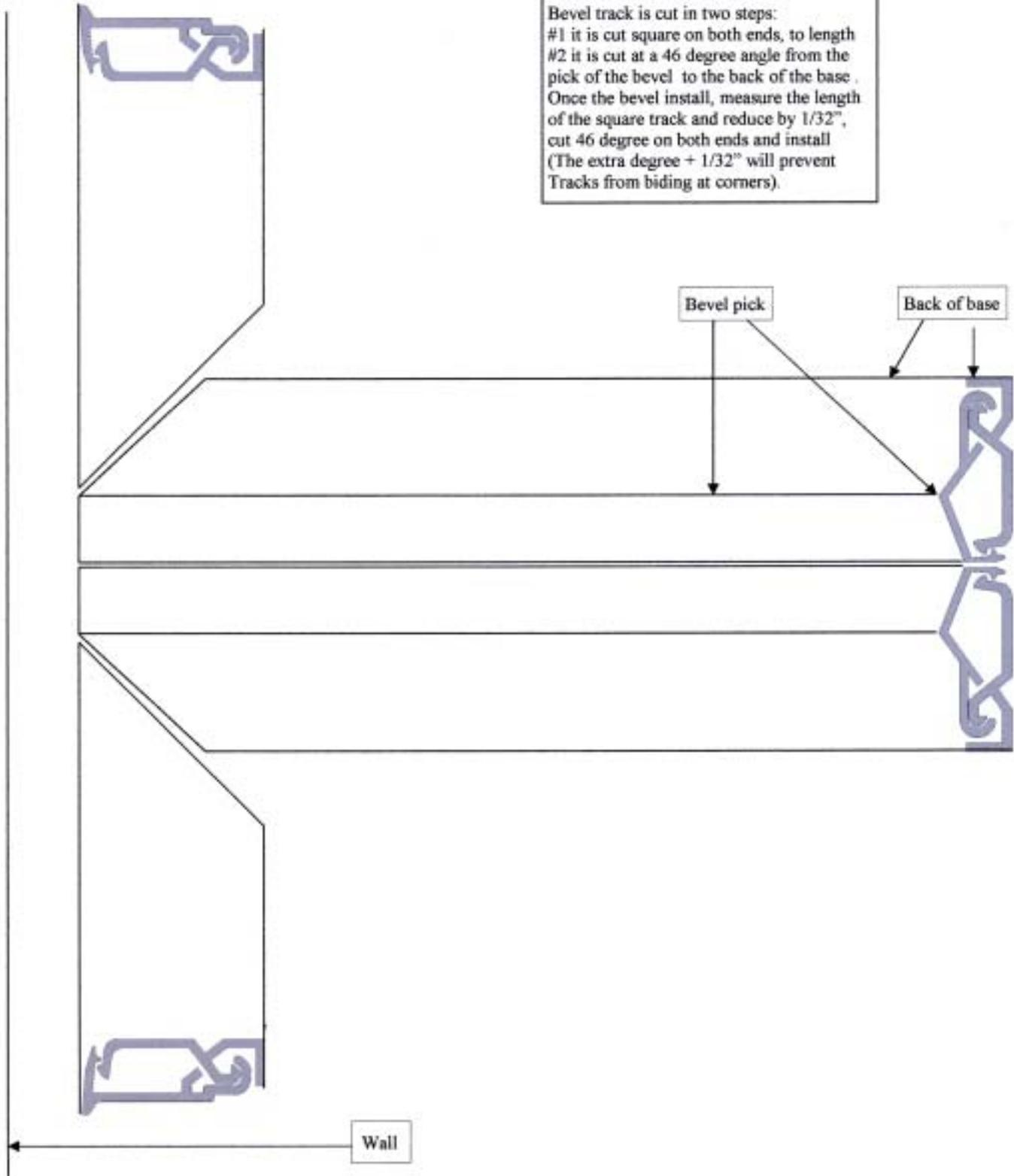

A 11. SPECIAL FINISH DETAILS

1. Using Bevel Profile To Create A Design

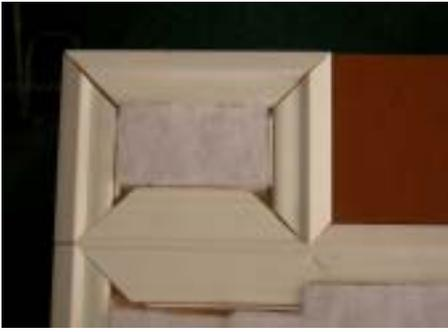

2. Diamond Shape with Bevel Track



3. Fitting Track to Moldings



4. Curves

